



***starcraft***<sup>®</sup>  
**PROFESSIONAL TOOLS**



**MASONRY BITS & CHISELS**

### 3004 / CONCRETE DRILL BITS, SANDBLASTED



- Professional quality.
- Made of high carbon steel with industrial grade carbide tip.
- Milled slow spiral for quick, easy debris removal.
- Sandblasted surface finish for anti-rust.
- Suitable for the Professionals.
- For use on rotary and percussion drills.
- For drilling in concrete, reinforced concrete, Brick and Block, Masonry, etc.

ITEM NO.	DIA. (MM)	OVERALL LENGTH (MM)	ITEM NO.	DIA. (INCH)	OVERALL LENGTH (INCH)
30040302N	4	75	30049302N	5/32	3
30040304N	5	85	30049303N	3/16	4
30040306N	6	100	30049306N	1/4	4
30040307N	7	100	30049307N	9/32	4
30040310N	8	120	30049310N	5/16	5
30040312N	10	120	30049311N	3/8	5
30040323N	12	150	30049320N	15/32	6
30040325N	14	150	30049322N	9/16	6
30040327N	16	150	30049323N	5/8	6
30040339N	8	200	30049330T	5/16	8
30040341N	10	200	30049331T	3/8	8
30040343N	12	200	30049332T	15/32	8
30040345N	14	200	30049334T	9/16	8
30040363T	8	400	30049355T	5/16	16
30040364T	10	400	30049356T	3/8	16
30040365T	12	400	30049357T	15/32	16
30040367T	14	400	30049359T	9/16	16
30040368T	16	400	30049360T	5/8	16
30040371T	20	400	30049361T	3/4	16

\* Drill bits with 200mm,300mm,400mm and 600mm overall length available.

\* Drill bits with 8", 12", 16" and 23" overall length available.



**INDIVIDUAL PACKAGE DISPLAY**  
PACKED IN TRAPPED BLISTER CARD



**Item No. 300404**  
**5pcs Concrete Drill Bits Set**  
in plastic box  
contains: 4, 5, 6, 8, 10mm



**Item No. 300406**  
**8pcs Concrete Drill Bits Set**  
in plastic box  
contains: 3, 4, 5, 6, 7, 8, 9, 10mm

**Item No. 300401**  
**5pcs Concrete Drill Bits**  
in plastic box with blister card  
contains: 4, 5, 6, 8, 10mm

**Item No. 300402**  
**8pcs Concrete Drill Bits**  
in plastic box with blister card  
contains: 3, 4, 5, 6, 7, 8, 9, 10mm

**Item No. 300405**  
**5pcs Concrete Drill Bits Set**  
in plastic box  
contains: 1/8, 3/16, 1/4, 5/16, 3/8 inch

**3007 / CONCRETE DRILL BITS, BLACK & SILVER**



- Professional quality.
- This drill bit is machined from high carbon steel with carbide tipped cutting edge.
- Black groove, polished edge.
- High quality for the Professionals.
- For use on rotary and percussion drills.
- For drilling in concrete, reinforced concrete, Brick and Block, Masonry, etc.

ITEM NO.	DIA. (MM)	OVERALL LENGTH (MM)	ITEM NO.	DIA. (INCH)	OVERALL LENGTH (INCH)
30070302N	4	75	30079302N	5/32	3
30070304N	5	85	30079303N	3/16	3
30070306N	6	100	30079306N	1/4	4
30070308N	7	100	30079307N	9/32	4
30070309N	8	120	30079311N	5/16	5
30070311N	10	120	30079312N	3/8	5
30070320N	12	150	30079320N	15/32	6
30070322N	14	150	30079322N	9/16	6
30070324N	16	150	30079323N	5/8	6
30070339N	8	200	30079329T	5/16	8
30070341N	10	200	30079330T	3/8	8
30070343N	12	200	30079331T	15/32	8
30070345N	14	200	30079333T	9/16	8
30070372T	8	400	30079349T	5/16	16
30070373T	10	400	30079350T	3/8	16
30070374T	12	400	30079351T	15/32	16
30070376T	14	400	30079353T	9/16	16
30070377T	16	400	30079354T	5/8	16
30070380T	20	400	30079355T	3/4	16

\* Drill bits with 200mm,300mm,400mm and 600mm overall length available.

\* Drill bits with 8",12",16" and 23" overall length available.



**INDIVIDUAL PACKAGE DISPLAY**  
PACKED IN TRAPPED BLISTER CARD



**Item No. 300704**  
**5pcs Concrete Drill Bits**  
Set in plastic box  
contains: 4, 5, 6, 8, 10mm



**Item No. 300706**  
**8pcs Concrete Drill Bits Set**  
in plastic box  
contains: 3, 4, 5, 6, 7, 8, 9, 10mm

**Item No. 300705**  
**5pcs Concrete Drill Bits Set**  
in plastic box  
contains:1/8, 3/16, 1/4, 5/16, 3/8 inch

**Item No. 300707**  
**7pcs Concrete Drill Bits Set**  
in plastic box  
contains: 1/8, 3/16, 1/4, 5/16, 3/8, 7/16, 1/2 inch

**Item No. 300709**  
**13pcs Concrete Drill Bits Set**  
in Metal box  
contains: 1/8, 5/32, 3/16, 7/32, 1/4, 9/32, 5/16, 11/32, 3/8, 13/32, 7/16, 15/32, 1/2 inch

### 3008 / MULTI-PURPOSE DRILL BITS, CARBIDE TIPPED





-  Triangle Shank
-  Straight Shank
-  1/4" Hex Shank



**INDIVIDUAL PACKAGE DISPLAY**  
PACKED IN TRAPPED BLISTER CARD

- Professional quality.
- Ground carbide tip for precise spot drilling, also reducing noise levels and drilling pressure.
- Extremely long life through special alloyed steel.
- Ideal for drilling through layers of different materials.
- For use on rotary drills.
- Professional usage.
- For drilling in materials like masonry, tile, wood, chipboard, metal and plastics.

 ITEM NO. Straight Shank	 ITEM NO. Triangle Shank	 ITEM NO. 1/4" Hex Shank	DIA. (MM)	OVERALL LENGTH (MM)
30080301N	-	-	3	70
-	-	30080335N	3	90
30080302N	-	-	4	75
-	-	30080336N	4	90
30080303N	-	30080337N	4	150
30080304N	-	30080338N	5	85
30080305N	-	30080339N	5	100
30080306N	-	30080340N	5	150
30080307N	-	30080341N	5.5	100
30080308N	-	30080342N	5.5	150
30080309N	30080370N	30080343N	6	100
30080310N	30080371N	30080344N	6	150
30080311N	30080372N	30080345N	6.5	100
30080312N	30080373N	30080346N	6.5	150
30080313N	30080374N	30080347N	7	100
30080314N	30080375N	30080348N	7	150
30080315N	30080376N	30080349N	8	120
30080316N	30080377N	30080350N	8	150
30080317N	30080378N	30080351N	8	200
30080318N	30080379N	30080352N	8	260
30080319N	30080380N	-	9	120
30080320N	30080381N	30080353N	10	120
30080321N	30080382N	30080354N	10	150
30080322N	30080383N	30080355N	10	200
30080323N	30080384N	30080356N	10	260
30080324N	30080385N	30080357N	11	150
30080325N	30080386N	30080358N	12	150
30080326N	30080387N	30080359N	12	200
30080327N	30080388N	30080360N	12	260
30080328N	30080389N	30080361N	13	150
30080329N	30080390N	30080362N	13	200
30080330N	30080391N	30080363N	14	150
30080331N	30080392N	30080364N	14	200
30080332N	30080393N	30080365N	14	260

**3009 / SCREW ANCHOR DRILL BITS - PROFESSIONAL**



- This drill bit is machined from high carbon steel with tungsten carbide tip.
- Ground double flute for fast, efficient removal of drilling.
- Sandblasted surface finish for anti-rust.
- Hardened carbon steel shaft for maximum strength.
- Used for installing concrete screw anchors.
- These bits meet the specifications of all of the major screw manufacturers.
- For drilling in brick, cement block, concrete and other types of masonry

ITEM NO.	DIA. (INCH)	OVERALL LENGTH (INCH)	FOR SCREW ANCHOR (INCH)
30090301N	5/32"   4mm	3-1/2"   89mm	3/16" x 1-1/4", 1-3/4"
30090302N	5/32"   4mm	4-1/2"   114mm	3/16" x 1-1/4", 1-3/4"
30090303N	5/32"   4mm	5-1/2"   140mm	3/16" x 3-1/4", 3-3/4", 4"
30090304N	3/16"   5mm	3-1/2"   89mm	1/4" x 1-1/4", 1-3/4"
30090305N	3/16"   5mm	4-1/2"   114mm	1/4" x 2-1/4", 2-3/4"
30090306N	3/16"   5mm	5-1/2"   140mm	1/4" x 3-1/4", 3-3/4", 4"
30090307N	1/4"   6mm	5-1/2"   140mm	5/16" x 2" to 3-1/2"
30090308N	5/32"   4mm	7"   178mm	3/16" x 1-1/4" to 4"



**INDIVIDUAL PACKAGE DISPLAY**  
PACKED IN TRAPPED BLISTER CARD

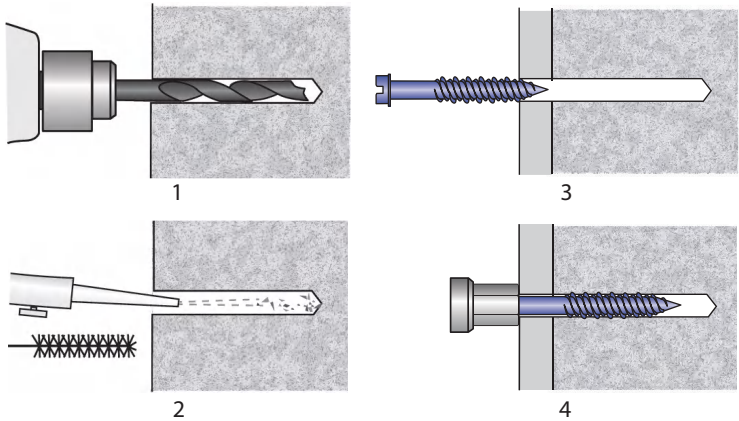

**INSTALLATION INFORMATION**  
**INSTRUCTIONS**

1. use the correct size anchor screw drill bit and drill the hole at least 1/4" deeper than the calculated embedment depth. it is recommended that a minimum of 1" and a maximum of 1-3/4" embedment be used.
2. clean the hole using a nylon brush and compressed air.
3. place the anchor point through the fixture into hole.
4. drive the anchor in a single continuous motion until the anchor is set firmly against the fixture.

### 3054 / GRANITE DRILL BITS, V-SLOTS TIP



- Industrial grade carbide tip withstands impact stress for superior cutting life.
- Super V-slots on tip for much faster penetration than standard masonry drill bit.
- Special flute design ensures efficient and speedy removal of dust for faster drilling and longer life.
- Especially suitable for drilling holes in granite, marble, and tile. Works on porcelain tile as well as ceramic tile, however porcelain tile will shorten the life of the drill.
- Use in all rotary or percussion drilling machines.

ITEM NO.	DIA. (MM)	OVERALL LENGTH (MM)
30540301N	3	76
30540303N	5	100
30540304N	6.5	100
30540308N	10	120

ITEM NO.	DIA. (INCH)	OVERALL LENGTH (INCH)
30549301N	1/8	3
30549303N	3/16	4
30549305N	1/4	4
30549318N	3/8	5



INDIVIDUAL PACKAGE DISPLAY  
PACKED IN TRAPPED BLISTER CARD

**3017 / GLASS & TILE DRILL BITS, STRAIGHT SHANK**



**INDIVIDUAL PACKAGE DISPLAY**  
PACKED IN TRAPPED BLISTER CARD

- Carbide spear point reduces cutting pressure for cleaner holes.
- Cuts a perfectly round hole without chipping or breaking.
- Best result with lower RPM and good cooling with water, vinegar and turpentine.
- For use with rotary drill only.
- For drilling glass, tile, mirrors and ceramics.

ITEM NO.	DIA. (INCH MM)	OVERALL LENGTH (INCH MM)
30170301N	1/8" 3mm	2-3/8" 60mm
30170302N	5/32" 4mm	2-3/8" 60mm
30170303N	3/16" 5mm	2-3/8" 60mm
30170304N	15/64" 6mm	2-3/8" 60mm
30170305N	1/4" 6.5mm	2-3/8" 60mm
30170306N	5/16" 8mm	3-1/8" 80mm
30170307N	3/8" 10mm	4" 100mm
30170308N	1/2" 12mm	4" 100mm

**3078 / CLASS & TILE DRILL BITS, 1/4" HEX SHANK**



**INDIVIDUAL PACKAGE DISPLAY**  
PACKED IN TRAPPED BLISTER CARD

- Made of hardened high carbon steel.
- Carbide spear point reduces cutting pressure for cleaner holes.
- Cuts a perfectly round hole with out chipping or breaking.
- Best result with lower RPM and good cooling with water, vinegar and turpentine.
- For drilling glass, tile, ceramics.
- 1/4-in. quick change hex shank fits all 1/4-in. quick change chucks and impact drivers.
- For use with rotary drills only.

ITEM NO.	DIA. (INCH MM)	OVERALL LENGTH (INCH MM)
30780301N	1/8" 3mm	2-3/8" 60mm
30780302N	5/32" 4mm	2-3/8" 60mm
30780303N	3/16" 5mm	2-3/8" 60mm
30780304N	15/64" 6mm	2-3/8" 60mm
30780305N	1/4" 6.5mm	2-3/8" 60mm
30780306N	5/16" 8mm	3-1/8" 80mm
30780307N	3/8" 10mm	4" 100mm
30780308N	1/2" 12mm	4" 100mm

 1/4" Hex Shank

### 3086 / TCT CROSS SPEAR HEAD GLASS & TILE DRILL BITS



- Made from industrial grade Carbide Point with 4 Cutting edges.
- 4 cutter design make the drilling more steady without any cracks on the edges of tiles and glass.
- Spear point reduces cutting pressure for cleaner holes.
- Cuts a perfectly round hole without chipping or breaking.
- Best result with lower rpm and good cooling with water, vinegar and turpentine.
- For use with rotary drills only.
- For drilling glass, ceramic, Plastic, Tile, Cement and more.



ITEM NO.	DIA. (INCH MM)	OVERALL LENGTH (INCH MM)
30860301N	4	75
30860302N	5	75
30860303N	6	75
30860304N	6	100
30860305N	6.5	75
30860306N	6.5	100
30860307N	8	120
30860308N	10	120
30860309N	12	120



**3010 / SDS-PLUS SHANK HAMMER DRILL BITS, 2 CUTTERS, VALUE PLUS**

- Small land and wide flute design for less heat build up and maximum dual removal.
- 2-Cutter design provides faster drilling speeds but also high precision.
- Value plus quality for efficient and fast hammer drilling in hard materials like concrete, granite, brick and other similar building materials.
- Fit into all hammers with the SDS-plus system.

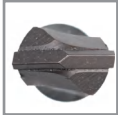

**INDIVIDUAL PACKAGE DISPLAY**  
PACKED IN PLASTIC HANGER

ITEM NO.	DIA. (MM)	OVERALL LENGTH (MM)
30100201H	4mm	110mm
30100202H	5mm	110mm
30100203H	5.5mm	110mm
30100204H	6mm	110mm
30100205H	6.5mm	110mm
30100206H	7mm	110mm
30100207H	8mm	110mm
30100208H	9mm	110mm
30100209H	10mm	110mm
30100210H	5mm	160mm
30100211H	6mm	160mm
30100212H	6.5mm	160mm
30100213H	7mm	160mm
30100214H	8mm	160mm
30100215H	9mm	160mm
30100216H	10mm	160mm
30100217H	11mm	160mm
30100218H	12mm	160mm
30100219H	13mm	160mm
30100220H	14mm	160mm
30100221H	15mm	160mm
30100222H	16mm	160mm
30100223H	5.5mm	210mm
30100224H	6mm	210mm
30100225H	6.5mm	210mm
30100226H	7mm	210mm
30100227H	8mm	210mm
30100228H	9mm	210mm
30100229H	10mm	210mm
30100230H	11mm	210mm
30100231H	12mm	210mm
30100232H	13mm	210mm
30100233H	14mm	210mm

ITEM NO.	DIA. (MM)	OVERALL LENGTH (MM)
30100234H	15mm	210mm
30100235H	16mm	210mm
30100236H	18mm	210mm
30100237H	20mm	210mm
30100238H	6mm	260mm
30100239H	7mm	260mm
30100240H	8mm	260mm
30100241H	10mm	260mm
30100242H	11mm	260mm
30100243H	12mm	260mm
30100244H	13mm	260mm
30100245H	14mm	260mm
30100246H	15mm	260mm
30100247H	16mm	260mm
30100248H	18mm	260mm
30100249H	20mm	260mm
30100250H	22mm	260mm
30100251H	24mm	260mm
30100252H	25mm	260mm
30100253H	26mm	260mm
30100254H	8mm	310mm
30100255H	10mm	310mm
30100256H	12mm	310mm
30100257H	13mm	310mm
30100258H	14mm	310mm
30100259H	16mm	310mm
30100260H	18mm	310mm
30100261H	20mm	310mm
30100262H	10mm	360mm
30100263H	12mm	360mm
30100264H	14mm	360mm
30100265H	16mm	360mm

ITEM NO.	DIA. (MM)	OVERALL LENGTH (MM)
30100266H	18mm	360mm
30100267H	20mm	360mm
30100268H	8mm	450mm
30100269H	10mm	450mm
30100270H	12mm	450mm
30100271H	14mm	450mm
30100272H	16mm	450mm
30100273H	18mm	450mm
30100274H	20mm	450mm
30100275H	22mm	450mm
30100276H	24mm	450mm
30100277H	25mm	450mm
30100278H	26mm	450mm
30100279H	8mm	600mm
30100280H	10mm	600mm
30100281H	14mm	600mm
30100282H	16mm	600mm
30100283H	18mm	600mm
30100284H	20mm	600mm
30100285H	22mm	600mm
30100286H	24mm	600mm
30100287H	25mm	600mm
30100288H	10mm	1000mm
30100289H	12mm	1000mm
30100290H	14mm	1000mm
30100291H	16mm	1000mm
30100292H	18mm	1000mm
30100293H	20mm	1000mm
30100294H	22mm	1000mm
30100295H	24mm	1000mm
30100296H	25mm	1000mm
30100297H	26mm	1000mm

ITEM NO.	DIA. (INCH)	USABLE LENGTH (INCH)	OVERALL LENGTH (INCH)
30109201H	5/32"	2"	4"
30109202H	3/16"	2"	4"
30109203H	1/4"	2"	4"
30109204H	5/32"	4"	6"
30109205H	3/16"	4"	6"
30109206H	7/32"	4"	6"
30109207H	1/4"	4"	6"
30109208H	5/16"	4"	6"
30109209H	3/8"	4"	6"
30109210H	7/16"	4"	6"
30109211H	1/2"	4"	6"
30109212H	9/16"	4"	6"
30109213H	5/8"	4"	6"
30109214H	3/16"	4"	6"
30109215H	7/32"	6"	8"
30109216H	1/4"	6"	8"
30109217H	5/8"	6"	8"
30109218H	11/16"	6"	8"
30109219H	3/4"	6"	8"
30109220H	27/32"	6"	8"
30109221H	7/8"	6"	8"
30109222H	3/16"	6"	8"
30109223H	7/32"	8"	10"
30109224H	1/4"	8"	10"
30109225H	3/8"	8"	10"
30109226H	1/2"	8"	10"
30109227H	3/4"	8"	10"
30109228H	1"	8"	10"
30109229H	1-1/16"	8"	10"

ITEM NO.	DIA. (INCH)	USABLE LENGTH (INCH)	OVERALL LENGTH (INCH)
30109230H	1-1/8"	8"	10"
30109231H	3/16"	10"	12"
30109232H	7/32"	10"	12"
30109233H	1/4"	10"	12"
30109234H	5/16"	10"	12"
30109235H	3/8"	10"	12"
30109236H	7/16"	10"	12"
30109237H	1/2"	10"	12"
30109238H	9/16"	10"	12"
30109239H	5/8"	10"	12"
30109240H	3/4"	10"	12"
30109241H	7/8"	10"	12"
30109242H	3/16"	12"	14"
30109243H	7/32"	12"	14"
30109244H	1/4"	12"	14"
30109245H	7/32	14"	16"
30109246H	1/4"	14"	16"
30109247H	3/8"	16"	18"
30109248H	7/16"	16"	18"
30109249H	1/2"	16"	18"
30109250H	9/16"	16"	18"
30109251H	5/8"	16"	18"
30109252H	3/4"	16"	18"
30109253H	7/8"	16"	18"
30109254H	1"	16"	18"
30109255H	1-1/8"	16"	18"
30109256H	3/8"	22"	24"
30109257H	5/8"	22"	24"
30109258H	3/4"	22"	24"

### 3032 / SDS-PLUS SHANK HAMMER DRILL BITS, 2 CUTTERS, PROFESSIONAL

- \* Fit into all hammers with the SDS-plus system.
- \* Extremely robust and wear resistant.
- \* Small land and wide flute design for less heat build up and maximum dual removal.
- \* Conforms to the demands of the Institute for Construction Engineering.
- \* Professional quality for efficient and fast hammer drilling in hard materials like concrete, granite, brick and other similar building materials.

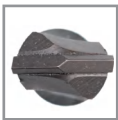

**INDIVIDUAL PACKAGE DISPLAY  
PACKED IN PLASTIC HANGER**

ITEM NO.	DIA. (MM)	OVERALL LENGTH (MM)
30320301H	5mm	110mm
30320302H	4mm	110mm
30320303H	5.5mm	110mm
30320304H	6mm	110mm
30320305H	6.5mm	110mm
30320306H	7mm	110mm
30320307H	8mm	110mm
30320308H	9mm	110mm
30320309H	10mm	110mm
30320310H	5mm	160mm
30320311H	6mm	160mm
30320312H	6.5mm	160mm
30320313H	7mm	160mm
30320314H	8mm	160mm
30320315H	9mm	160mm
30320316H	10mm	160mm
30320317H	11mm	160mm
30320318H	12mm	160mm
30320319H	13mm	160mm
30320320H	14mm	160mm
30320321H	15mm	160mm
30320322H	16mm	160mm
30320323H	5.5mm	210mm
30320324H	6mm	210mm
30320325H	6.5mm	210mm
30320326H	7mm	210mm
30320327H	8mm	210mm
30320328H	9mm	210mm
30320329H	10mm	210mm
30320330H	11mm	210mm
30320331H	12mm	210mm
30320332H	13mm	210mm
30320333H	14mm	210mm

ITEM NO.	DIA. (MM)	OVERALL LENGTH (MM)
30320334H	15mm	210mm
30320335H	16mm	210mm
30320336H	18mm	210mm
30320337H	20mm	210mm
30320338H	6mm	260mm
30320339H	7mm	260mm
30320340H	8mm	260mm
30320341H	10mm	260mm
30320342H	11mm	260mm
30320343H	12mm	260mm
30320344H	13mm	260mm
30320345H	14mm	260mm
30320346H	15mm	260mm
30320347H	16mm	260mm
30320348H	18mm	260mm
30320349H	20mm	260mm
30320350H	22mm	260mm
30320351H	24mm	260mm
30320352H	25mm	260mm
30320353H	26mm	260mm
30320354H	8mm	310mm
30320355H	10mm	310mm
30320356H	12mm	310mm
30320357H	13mm	310mm
30320358H	14mm	310mm
30320359H	16mm	310mm
30320360H	18mm	310mm
30320361H	20mm	310mm
30320362H	10mm	360mm
30320363H	12mm	360mm
30320364H	14mm	360mm
30320365H	16mm	360mm

ITEM NO.	DIA. (MM)	OVERALL LENGTH (MM)
30320366H	18mm	360mm
30320367H	20mm	360mm
30320368H	8mm	450mm
30320369H	10mm	450mm
30320370H	12mm	450mm
30320371H	14mm	450mm
30320372H	16mm	450mm
30320373H	18mm	450mm
30320374H	20mm	450mm
30320375H	22mm	450mm
30320376H	24mm	450mm
30320377H	25mm	450mm
30320378H	26mm	450mm
30320379H	8mm	600mm
30320380H	10mm	600mm
30320381H	14mm	600mm
30320382H	16mm	600mm
30320383H	18mm	600mm
30320384H	20mm	600mm
30320385H	22mm	600mm
30320386H	24mm	600mm
30320387H	25mm	600mm
30320388H	10mm	1000mm
30320389H	12mm	1000mm
30320390H	14mm	1000mm
30320391H	16mm	1000mm
30320392H	18mm	1000mm
30320393H	20mm	1000mm
30320394H	22mm	1000mm
30320395H	24mm	1000mm
30320396H	25mm	1000mm
30320397H	26mm	1000mm

ITEM NO.	DIA. (INCH)	USABLE LENGTH (INCH)	OVERALL LENGTH (INCH)
30329301H	5/32"	2"	4"
30329302H	3/16"	2"	4"
30329303H	1/4"	2"	4"
30329304H	5/32"	4"	6"
30329305H	3/16"	4"	6"
30329306H	7/32"	4"	6"
30329307H	1/4"	4"	6"
30329308H	5/16"	4"	6"
30329309H	3/8"	4"	6"
30329310H	7/16"	4"	6"
30329311H	1/2"	4"	6"
30329312H	9/16"	4"	6"
30329313H	5/8"	4"	6"
30329314H	3/16"	6"	8"
30329315H	7/32"	6"	8"
30329316H	1/4"	6"	8"
30329317H	5/8"	6"	8"
30329318H	11/16"	6"	8"
30329319H	3/4"	6"	8"
30329320H	27/32"	6"	8"
30329321H	7/8"	6"	8"
30329322H	3/16"	8"	10"
30329323H	7/32"	8"	10"
30329324H	1/4"	8"	10"
30329325H	3/8"	8"	10"
30329326H	1/2"	8"	10"
30329327H	3/4"	8"	10"
30329328H	1"	8"	10"
30329329H	1-1/16"	8"	10"

ITEM NO.	DIA. (INCH)	USABLE LENGTH (INCH)	OVERALL LENGTH (INCH)
30329330H	1-1/8"	8"	10"
30329331H	3/16"	10"	12"
30329332H	7/32"	10"	12"
30329333H	1/4"	10"	12"
30329334H	5/16"	10"	12"
30329335H	3/8"	10"	12"
30329336H	7/16"	10"	12"
30329337H	1/2"	10"	12"
30329338H	9/16"	10"	12"
30329339H	5/8"	10"	12"
30329340H	3/4"	10"	12"
30329341H	7/8"	10"	12"
30329342H	3/16"	12"	14"
30329343H	7/32"	12"	14"
30329344H	1/4"	12"	14"
30329345H	7/32"	14"	16"
30329346H	1/4"	14"	16"
30329347H	3/8"	16"	18"
30329348H	7/16"	16"	18"
30329349H	1/2"	16"	18"
30329350H	9/16"	16"	18"
30329351H	5/8"	16"	18"
30329352H	3/4"	16"	18"
30329353H	7/8"	16"	18"
30329354H	1"	16"	18"
30329355H	1-1/8"	16"	18"
30329356H	3/8"	22"	24"
30329357H	5/8"	22"	24"
30329358H	3/4"	22"	24"

**3077 / SDS-PLUS SHANK HAMMER DRILL BITS, 2 CUTTERS WITH CENTRIC TIP**

- Fit into all hammers with the SDS-plus system.
- Centric tip for optimal hole geometry and provides quick, accurate starts on spot drilling.
- Small land and wide flute design for less heat build up and maximum dual removal.
- Conforms to the demands of the Institute for Construction Engineering.
- Ideal for anchoring and through-hole applications in concrete.



ITEM NO.	DIA. (MM)	OVERALL LENGTH (MM)
30770301H	4mm	110mm
30770302H	4mm	160mm
30770303H	5mm	110mm
30770304H	5mm	160mm
30770305H	5.5mm	110mm
30770306H	5.5mm	160mm
30770307H	5.5mm	210mm
30770308H	6mm	110mm
30770309H	6mm	160mm
30770310H	6mm	210mm
30770311H	6mm	260mm
30770312H	6mm	350mm
30770313H	6.5mm	110mm
30770314H	6.5mm	160mm
30770315H	6.5mm	210mm
30770316H	6.5mm	260mm
30770317H	7mm	110mm
30770318H	7mm	160mm
30770319H	8mm	110mm
30770320H	8mm	160mm
30770321H	8mm	210mm
30770322H	8mm	260mm
30770323H	8mm	310mm
30770324H	8mm	350mm
30770325H	8mm	400mm
30770326H	8mm	460mm
30770327H	9mm	110mm
30770328H	9mm	160mm
30770329H	9mm	210mm
30770330H	10mm	110mm
30770331H	10mm	160mm
30770332H	10mm	210mm
30770333H	10mm	260mm

ITEM NO.	DIA. (MM)	OVERALL LENGTH (MM)
30770334H	10mm	310mm
30770335H	10mm	350mm
30770336H	10mm	400mm
30770337H	10mm	460mm
30770338H	10mm	600mm
30770339H	10mm	800mm
30770340H	10mm	1000mm
30770341H	11mm	110mm
30770342H	11mm	160mm
30770343H	11mm	210mm
30770344H	12mm	110mm
30770345H	12mm	160mm
30770346H	12mm	210mm
30770347H	12mm	260mm
30770348H	12mm	310mm
30770349H	12mm	350mm
30770350H	12mm	400mm
30770351H	12mm	460mm
30770352H	12mm	600mm
30770353H	12mm	800mm
30770354H	12mm	1000mm
30770355H	13mm	160mm
30770356H	13mm	210mm
30770357H	13mm	260mm
30770358H	13mm	310mm
30770359H	13mm	350mm
30770360H	14mm	160mm
30770361H	14mm	210mm
30770362H	14mm	260mm
30770363H	14mm	310mm
30770364H	14mm	350mm
30770365H	14mm	400mm

ITEM NO.	DIA. (MM)	OVERALL LENGTH (MM)
30770366H	14mm	460mm
30770367H	14mm	600mm
30770368H	14mm	800mm
30770369H	14mm	1000mm
30770370H	15mm	160mm
30770371H	16mm	160mm
30770372H	16mm	210mm
30770373H	16mm	260mm
30770374H	16mm	310mm
30770375H	16mm	350mm
30770376H	16mm	400mm
30770377H	16mm	460mm
30770378H	16mm	600mm
30770379H	16mm	800mm
30770380H	16mm	1000mm
30770381H	18mm	210mm
30770382H	18mm	260mm
30770383H	18mm	310mm
30770384H	18mm	350mm
30770385H	18mm	400mm
30770386H	18mm	460mm
30770387H	18mm	600mm
30770388H	18mm	800mm
30770389H	18mm	1000mm
30770390H	20mm	210mm
30770391H	20mm	260mm
30770392H	20mm	310mm
30770393H	20mm	350mm
30770394H	20mm	400mm
30770395H	20mm	460mm
30770396H	20mm	600mm
30770397H	20mm	800mm
30770398H	20mm	1000mm
30770399H	22mm	260mm
307703100H	22mm	310mm
307703101H	22mm	350mm
307703102H	22mm	400mm
307703103H	22mm	460mm
307703104H	22mm	600mm
307703105H	22mm	800mm

**INDIVIDUAL PACKAGE DISPLAY**  
PACKED IN PLASTIC HANGER

### 3080 / SDS-PLUS SHANK HAMMER DRILL BITS, 4 CUTTERS, VALUE PLUS

- Small land and wide flute design for less heat build up and maximum dual removal.
- 4 carbide cutters provide longer life and reduce vibration for drilling smoother, rounder holes than standard masonry drill bits.
- Value plus quality for efficient and fast hammer drilling in hard materials like concrete, granite, brick and other similar building materials.
- Fit into all hammers with the SDS-plus system.



ITEM NO.	DIA. (MM)	OVERALL LENGTH (MM)
30800201H	6mm	110mm
30800204H	6mm	160mm
30800211H	6mm	210mm
30800223H	6mm	260mm
30800202H	8mm	110mm
30800205H	8mm	160mm
30800212H	8mm	210mm
30800224H	8mm	260mm
30800206H	10mm	160mm
30800213H	10mm	210mm
30800225H	10mm	260mm
30800237H	10mm	310mm
30800236H	8mm	310mm
30800249H	8mm	350mm
30800262H	8mm	400mm
30800275H	8mm	460mm
30800203H	10mm	110mm
30800250H	10mm	350mm
30800263H	10mm	400mm
30800276H	10mm	460mm
30800290H	10mm	600mm
308002104H	10mm	800mm
30800207H	12mm	160mm
30800214H	12mm	210mm
30800226H	12mm	260mm
30800238H	12mm	310mm
30800251H	12mm	350mm
30800264H	12mm	400mm
30800277H	12mm	460mm
30800291H	12mm	600mm

ITEM NO.	DIA. (MM)	OVERALL LENGTH (MM)
308002105H	12mm	800mm
308002118H	12mm	1000mm
30800208H	13mm	160mm
30800215H	13mm	210mm
30800227H	13mm	260mm
30800239H	13mm	310mm
30800252H	13mm	350mm
30800265H	13mm	400mm
30800278H	13mm	460mm
30800292H	13mm	600mm
308002106H	13mm	800mm
30800209H	14mm	160mm
30800216H	14mm	210mm
30800228H	14mm	260mm
30800240H	14mm	310mm
30800253H	14mm	350mm
30800266H	14mm	400mm
30800279H	14mm	460mm
30800293H	14mm	600mm
308002107H	14mm	800mm
308002119H	14mm	1000mm
30800210H	16mm	160mm
30800217H	16mm	210mm
30800229H	16mm	260mm
30800241H	16mm	310mm
30800254H	16mm	350mm
30800267H	16mm	400mm
30800280H	16mm	460mm
30800294H	16mm	600mm
308002108H	16mm	800mm
308002120H	16mm	1000mm

ITEM NO.	DIA. (MM)	OVERALL LENGTH (MM)
30800218H	18mm	210mm
30800230H	18mm	260mm
30800242H	18mm	310mm
30800255H	18mm	350mm
30800268H	18mm	400mm
30800281H	18mm	460mm
30800295H	18mm	600mm
308002109H	18mm	800mm
308002121H	18mm	1000mm
30800219H	20mm	210mm
30800231H	20mm	260mm
30800243H	20mm	310mm
30800256H	20mm	350mm
30800269H	20mm	400mm
30800282H	20mm	460mm
30800296H	20mm	600mm
308002110H	20mm	800mm
308002122H	20mm	1000mm
30800220H	22mm	210mm
30800232H	22mm	260mm
30800244H	22mm	310mm
30800257H	22mm	350mm
30800270H	22mm	400mm
30800283H	22mm	460mm
30800297H	22mm	600mm
308002111H	22mm	800mm
308002123H	22mm	1000mm
30800221H	24mm	210mm
30800233H	24mm	260mm
30800245H	24mm	310mm
30800258H	24mm	350mm



INDIVIDUAL PACKAGE DISPLAY  
PACKED IN PLASTIC HANGER

ITEM NO.	DIA. (MM)	OVERALL LENGTH (MM)
30800271H	24mm	400mm
30800284H	24mm	460mm
30800298H	24mm	600mm
308002112H	24mm	800mm
308002124H	24mm	1000mm
30800222H	25mm	210mm
30800234H	25mm	260mm
30800246H	25mm	310mm
30800259H	25mm	350mm
30800272H	25mm	400mm
30800285H	25mm	460mm
30800299H	25mm	600mm
308002113H	25mm	800mm
308002125H	25mm	1000mm
30800235H	26mm	260mm
30800247H	26mm	310mm
30800260H	26mm	350mm
30800273H	26mm	400mm
30800286H	26mm	460mm

ITEM NO.	DIA. (MM)	OVERALL LENGTH (MM)
308002100H	26mm	600mm
308002114H	26mm	800mm
308002126H	26mm	1000mm
30800248H	28mm	310mm
30800261H	28mm	350mm
30800274H	28mm	400mm
30800287H	28mm	460mm
308002101H	28mm	600mm
308002115H	28mm	800mm
308002127H	28mm	1000mm
30800288H	30mm	460mm
308002102H	30mm	600mm
308002116H	30mm	800mm
308002128H	30mm	1000mm
30800289H	32mm	460mm
308002103H	32mm	600mm
308002117H	32mm	800mm
308002129H	32mm	1000mm

**3081 / SDS-PLUS SHANK HAMMER DRILL BITS, 4 POWERFUL CROSS CUTTERS HEAD**

- Small land and wide flute design for less heat build up and maximum dual removal.
- 4 carbide cutters provide longer life and reduce vibration for drilling smoother, rounder holes than standard masonry drill bits.
- Value plus quality for efficient and fast hammer drilling in hard materials like concrete, granite, brick and other similar building materials.
- Fit into all hammers with the SDS-plus system.

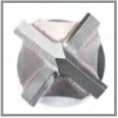

ITEM NO.	DIA. (MM)	OVERALL LENGTH (MM)
30810301H	6mm	110mm
30810302H	6mm	160mm
30810303H	6mm	210mm
30810304H	6mm	260mm
30810305H	6mm	310mm
30810306H	8mm	110mm
30810307H	8mm	160mm
30810308H	8mm	210mm
30810309H	8mm	260mm
30810310H	8mm	310mm
30810311H	8mm	350mm
30810312H	8mm	450mm
30810313H	10mm	110mm
30810314H	10mm	160mm
30810315H	10mm	210mm
30810316H	10mm	260mm
30810317H	10mm	310mm
30810318H	10mm	350mm
30810319H	10mm	400mm
30810320H	10mm	450mm
30810321H	10mm	600mm
30810322H	12mm	110mm
30810323H	12mm	160mm
30810324H	12mm	210mm
30810325H	12mm	260mm
30810326H	12mm	310mm
30810327H	12mm	350mm
30810328H	12mm	400mm
30810329H	12mm	450mm
30810330H	12mm	600mm

ITEM NO.	DIA. (MM)	OVERALL LENGTH (MM)
30810331H	14mm	160mm
30810332H	14mm	210mm
30810333H	14mm	260mm
30810334H	14mm	310mm
30810335H	14mm	350mm
30810336H	14mm	400mm
30810337H	14mm	450mm
30810338H	14mm	600mm
30810339H	16mm	160mm
30810340H	16mm	210mm
30810341H	16mm	260mm
30810342H	16mm	310mm
30810343H	16mm	350mm
30810344H	16mm	400mm
30810345H	16mm	450mm
30810346H	16mm	600mm
30810347H	18mm	210mm
30810348H	18mm	260mm
30810349H	18mm	310mm
30810350H	18mm	350mm
30810351H	18mm	400mm
30810352H	18mm	450mm
30810353H	18mm	600mm
30810354H	20mm	210mm
30810355H	20mm	260mm
30810356H	20mm	310mm
30810357H	20mm	350mm
30810358H	20mm	400mm
30810359H	20mm	450mm
30810360H	20mm	600mm
30810361H	22mm	210mm

ITEM NO.	DIA. (MM)	OVERALL LENGTH (MM)
30810362H	22mm	260mm
30810363H	22mm	310mm
30810364H	22mm	350mm
30810365H	22mm	400mm
30810366H	22mm	450mm
30810367H	22mm	600mm
30810368H	25mm	210mm
30810369H	25mm	260mm
30810370H	25mm	310mm
30810371H	25mm	350mm
30810372H	25mm	400mm
30810373H	25mm	450mm
30810374H	25mm	600mm



**INDIVIDUAL PACKAGE DISPLAY**  
PACKED IN PLASTIC HANGER

## 3082 / SDS-PLUS SHANK HAMMER DRILL BITS, 4 FLUTES, SOLID CARBIDE CUTTER

### SDS-PLUS FULL HEAD HAMMER DRILL BIT

#### Pyramid-shaped centering tip

Precise drilling engagement into concrete and symmetrical drilled hole.

#### 4 Cutter solid tungsten carbide tips

Premium solid carbide tip Provide impact-resistance during high speed drilling.

#### 4 Fluted Spiral Geometry

The 4 flutes ensure rapid dust removal and low vibration.

#### Unique High temperature welding

Extremely hard wearing for the longest lifetime.

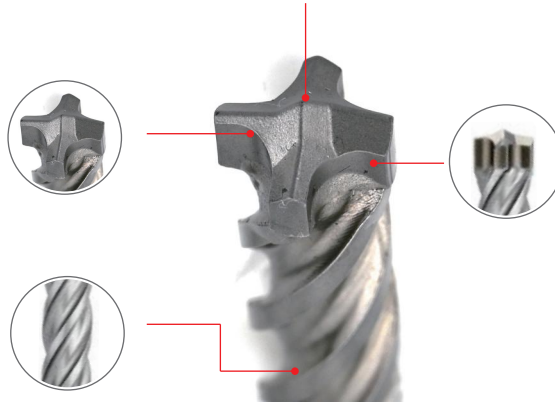

- Small land and wide flute design for less heat build up and maximum dust removal.
- 4-Cutter design provides faster drilling speeds but also high precision.
- Value plus quality for efficient and fast hammer drilling in hard materials like concrete, granite, brick and other similar building materials.
- Fit into all hammers with the SDS-plus system.



INDIVIDUAL PACKAGE DISPLAY  
PACKED IN PLASTIC HANGER

ITEM NO.	DIA. (MM)	OVERALL LENGTH (MM)	ITEM NO.	DIA. (MM)	OVERALL LENGTH (MM)
30820301H	6mm	110mm	30820324H	14mm	160mm
30820302H	6mm	160mm	30820325H	14mm	210mm
30820303H	6mm	210mm	30820326H	14mm	260mm
30820304H	8mm	110mm	30820327H	14mm	310mm
30820305H	8mm	160mm	30820328H	14mm	350mm
30820306H	8mm	210mm	30820329H	14mm	400mm
30820307H	8mm	260mm	30820330H	14mm	450mm
30820308H	8mm	310mm	30820331H	16mm	160mm
30820309H	8mm	350mm	30820332H	16mm	210mm
30820310H	10mm	110mm	30820333H	16mm	260mm
30820311H	10mm	160mm	30820334H	16mm	310mm
30820312H	10mm	210mm	30820335H	16mm	350mm
30820313H	10mm	260mm	30820336H	16mm	400mm
30820314H	10mm	310mm	30820337H	16mm	450mm
30820315H	10mm	350mm			
30820316H	12mm	110mm			
30820317H	12mm	160mm			
30820318H	12mm	210mm			
30820319H	12mm	260mm			
30820320H	12mm	310mm			
30820321H	12mm	350mm			
30820322H	12mm	400mm			
30820323H	12mm	450mm			

**3079 / SDS-MAX SHANK HAMMER DRILL BITS, 2 CUTTERS, PROFESSIONAL**

- Features 2-cutter design and rugged carbide plate.
- Supreme grade carbide tips ensure fast penetration and durability.
- Double flutes with progressive angles produce straighter holes and faster dust removal.
- Fast 2-cutter for all concrete and stone applications.
- Fits large rotary hammers with the SDS-Max tool holder system.
- For drilling larger diameter holes in concrete, stone and masonry.

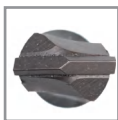

**INDIVIDUAL PACKAGE DISPLAY**  
PACKED IN PLASTIC HANGER

ITEM NO.	DIA. (MM)	OVERALL LENGTH (MM)
30790201H	10mm	260mm
30790209H	10mm	340mm
30790202H	12mm	260mm
30790210H	12mm	340mm
30790220H	12mm	540mm
30790203H	14mm	260mm
30790211H	14mm	340mm
30790221H	14mm	400mm
30790204H	14mm	540mm
30790212H	16mm	260mm
30790222H	16mm	340mm
30790233H	16mm	400mm
30790234H	16mm	540mm
30790205H	18mm	260mm
30790213H	18mm	340mm
30790223H	18mm	400mm
30790235H	18mm	540mm
30790247H	18mm	600mm
30790258H	18mm	800mm
30790267H	18mm	1000mm
30790206H	20mm	260mm
30790214H	20mm	340mm
30790224H	20mm	400mm

ITEM NO.	DIA. (INCH)	OVERALL LENGTH (INCH)
30790251H	28mm	1000mm
30790271H	30mm	340mm
30790218H	30mm	400mm
30790228H	30mm	540mm
30790241H	30mm	600mm
30790252H	30mm	800mm
30790262H	30mm	1000mm
30790272H	32mm	340mm
30790219H	32mm	400mm
30790229H	32mm	540mm
30790242H	32mm	600mm
30790253H	32mm	800mm
30790263H	32mm	1000mm
30790273H	35mm	400mm
30790230H	35mm	540mm
30790243H	35mm	600mm
30790254H	35mm	800mm
30790264H	35mm	1000mm
30790274H	38mm	400mm
30790231H	38mm	540mm
30790255H	38mm	600mm
30790265H	38mm	800mm
30790275H	38mm	1000mm
30790232H	40mm	400mm
30790244H	40mm	540mm
30790256H	40mm	600mm
30790266H	40mm	800mm
30790276H	40mm	1000mm
30790257H	42mm	600mm
30790277H	42mm	1000mm
30790245H	45mm	540mm
30790278H	45mm	1000mm
30790246H	52mm	540mm
30790279H	52mm	1000mm

ITEM NO.	DIA. (MM)	OVERALL LENGTH (MM)
30790236H	20mm	540mm
30790248H	20mm	600mm
30790259H	20mm	800mm
30790268H	20mm	1000mm
30790207H	22mm	260mm
30790215H	22mm	340mm
30790225H	22mm	400mm
30790237H	22mm	540mm
30790249H	22mm	600mm
30790260H	22mm	800mm
30790269H	22mm	1000mm
30790238H	25mm	260mm
30790208H	25mm	340mm
30790216H	25mm	400mm
30790226H	25mm	540mm
30790239H	25mm	600mm
30790250H	25mm	800mm
30790261H	25mm	1000mm
30790270H	28mm	340mm
30790217H	28mm	400mm
30790227H	28mm	540mm
30790240H	28mm	600mm

### 3083 / SDS-MAX SHANK HAMMER DRILL BITS, 4 FLUTES, POWERFUL CROSS CUTTER HEAD

- Features 4-cutter design and rugged carbide plate.
- Supreme grade carbide tips ensure fast penetration and durability.
- Double flutes with progressive angles produce straighter holes and faster dust removal.
- Fast 4-cutter for all concrete and stone applications.
- Fits large rotary hammers with the SDS-Max tool holder system.
- For drilling larger diameter holes in concrete, stone and masonry.

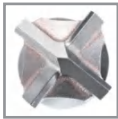

INDIVIDUAL PACKAGE DISPLAY  
PACKED IN PLASTIC HANGER

ITEM NO.	DIA. (MM)	OVERALL LENGTH (MM)
30830301H	10mm	280mm
30830302H	10mm	340mm
30830303H	10mm	400mm
30830304H	10mm	500mm
30830305H	12mm	280mm
30830306H	12mm	340mm
30830307H	12mm	400mm
30830308H	12mm	500mm
30830309H	14mm	280mm
30830310H	14mm	340mm
30830311H	14mm	400mm
30830312H	14mm	500mm
30830313H	14mm	600mm
30830314H	16mm	280mm
30830315H	16mm	340mm
30830316H	16mm	400mm
30830317H	16mm	500mm
30830318H	16mm	600mm
30830319H	18mm	280mm
30830320H	18mm	340mm
30830321H	18mm	400mm
30830322H	18mm	500mm
30830323H	18mm	600mm

ITEM NO.	DIA. (INCH)	OVERALL LENGTH (INCH)
30830346H	28mm	340mm
30830347H	28mm	400mm
30830348H	28mm	500mm
30830349H	28mm	600mm
30830350H	28mm	800mm
30830351H	28mm	1000mm
30830352H	30mm	280mm
30830353H	30mm	340mm
30830354H	30mm	400mm
30830355H	30mm	500mm
30830356H	30mm	600mm
30830357H	30mm	800mm
30830358H	30mm	1000mm
30830359H	32mm	280mm
30830360H	32mm	340mm
30830361H	32mm	400mm
30830362H	32mm	500mm
30830363H	32mm	600mm
30830364H	32mm	800mm
30830365H	32mm	1000mm
30830366H	35mm	280mm
30830367H	35mm	340mm
30830368H	35mm	400mm
30830369H	35mm	500mm
30830370H	35mm	600mm
30830371H	35mm	800mm
30830372H	35mm	1000mm
30830373H	38mm	280mm
30830374H	38mm	340mm
30830375H	38mm	400mm
30830376H	38mm	500mm
30830377H	38mm	600mm
30830378H	38mm	800mm
30830379H	38mm	1000mm

ITEM NO.	DIA. (MM)	OVERALL LENGTH (MM)
30830324H	20mm	280mm
30830325H	20mm	340mm
30830326H	20mm	400mm
30830327H	20mm	500mm
30830328H	20mm	600mm
30830329H	20mm	800mm
30830330H	20mm	1000mm
30830331H	22mm	280mm
30830332H	22mm	340mm
30830333H	22mm	400mm
30830334H	22mm	500mm
30830335H	22mm	600mm
30830336H	22mm	800mm
30830337H	22mm	1000mm
30830338H	25mm	280mm
30830339H	25mm	340mm
30830340H	25mm	400mm
30830341H	25mm	500mm
30830342H	25mm	600mm
30830343H	25mm	800mm
30830344H	25mm	1000mm
30830345H	28mm	280mm

ITEM NO.	DIA. (INCH)	OVERALL LENGTH (INCH)
30830380H	40mm	400mm
30830381H	40mm	500mm
30830382H	40mm	600mm
30830383H	40mm	800mm
30830384H	40mm	1000mm



**3084 / TCT COUNTERSINK DEPTH GAUGE DRILL BITS**



PACKED IN TRAPPED BLISTER CARD

1/4" Hex Shank

- Tungsten carbide tipped countersink for extended life.
- Drills and countersinks fiber cement sheets in one process.
- Cuts up to 18mm thick material.
- 90° countersink angle.
- Designed to save time installing CFC & Blueboard ect.by easily countersinking screw heads.
- 1/4" quick change suits hammer action portable power drills.

ITEM NO.	DIA. (MM)	COUNTERSINK DIAMETER (MM)	CUTTING DEPTH (MM)	COUNTERSINK ANGLE	SUITS SCREW GAUGE
30840001N	5mm	11mm	9mm	90°	8G
30840002N	5mm	11mm	18mm	90°	8G
30840003N	6mm	11mm	9mm	90°	10G
30840004N	6mm	11mm	18mm	90°	10G

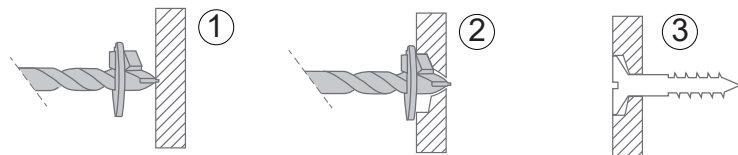

**3085 / TCT CONSTRUCTION DRILL WITH 1/4" HEX SHANK**



1/4" Hex Shank

- Carbide tipped provides longer bit life.
- Designed for use in masonry and concrete material.
- Impact rated for increased durability.
- Wide flute for optimized material removal.
- 1/4-inch Hex shank for use in a hammer drill or impact driver.
- For best results, use in hammer mode in hammer drill.

ITEM NO.	DIA. (MM)	OVERALL LENGTH (MM)
30850301N	3mm	100mm
30850302N	4mm	100mm
30850303N	5mm	100mm
30850304N	5.5mm	100mm
30850305N	6mm	100mm
30850306N	6.5mm	100mm
30850307N	7mm	100mm
30850308N	8mm	100mm
30850309N	10mm	100mm
30850310N	12mm	100mm

### 3099 / MULTI-MATERIAL DRILL BITS



**2-GROOVE  
1/4" Hex Shank**

- Multi-purpose, drills wood, metal, masonry, plastic, tile, etc.
- Tungsten carbide tip, wear-resistant and durable.
- Precise point positioning, less walking.
- Smooth chip removal, no clogging.
- Fits standard drills and impact drills.
- Ideal for home renovation & DIY mixed materials



#### 309901

**12pcs Multi-material  
Drill Bits In Plastic Case**  
contains:

2x (5/32", 3/16", 7/32", 1/4", 5/16", 3/8", 1/2")

#### 309902

**12pcs Multi-material  
Drill Bits In Plastic Case**  
contains:

2x (4mm, 5mm, 6mm, 7mm, 8mm, 10mm, 12mm)

ITEM NO.	DIA. (MM)	OVERALL LENGTH (MM)	ITEM NO.	DIA. (INCH)	OVERALL LENGTH (INCH)
30990301N	4mm	152mm	30999301N	5/32"	6"
30990302N	5mm	152mm	30999302N	3/16"	6"
30990303N	6mm	152mm	30999303N	7/32"	6"
30990304N	7mm	152mm	30999304N	1/4"	6"
30990305N	8mm	152mm	30999305N	5/16"	6"
30990306N	10mm	152mm	30999306N	3/8"	6"
30990307N	12mm	152mm	30999307N	1/2"	6"

### DRILL BITS SETS



#### 990402

**13pcs SDS-plus shank hammer bits  
and chisels set in Aluminum case**  
contains:

- 4X 110mm SDS-plus shank hammer drill bit-Ø5,6,7,8mm
- 7X 160mm SDS-plus shank hammer drill bit-Ø6,7,8,10,12,14,16mm
- 2X 250mm SDS-plus shank steel chisel-bull point, flat 20mm



#### 990401

**17pcs SDS-plus shank hammer bits  
and chisels set in Aluminum case**  
contains:

- 4X 110mm SDS-plus shank hammer drill bit-Ø5,6,8,10mm
- 4X 160mm SDS-plus shank hammer drill bit-Ø6,8,10,12mm
- 2X 210mm SDS-plus shank hammer drill bit-Ø8,10mm
- 2X 260mm SDS-plus shank hammer drill bit-Ø12,14mm
- 2X 140mm SDS-plus shank steel chisel-bull pint, flat 20mm
- 3X 250mm SDS-plus shank steel chisel-bull point, flat 20,40mm



#### 990403

**10pcs SDS-plus shank hammer bits  
and chisels set in Aluminum case**  
contains:

- 1X SDS-plus shank hammer drill bit-Ø6x110mm
- 1X SDS-plus shank hammer drill bit-Ø8x160mm
- 2X 210mm SDS-plus shank hammer drill bit-Ø10,12mm
- 4X 460mm SDS-plus shank hammer drill bit-Ø10,12,16,20mm
- 2X 250mm SDS-plus shank steel chisel-bull point, flat 20mm

## 3021 / SDS-PLUS SHANK HAMMER STEEL CHISELS

### SDS-PLUS SHANK WITH ROUND SHAFT

- SDS-plus shank for light rotary and demolition hammers.
- Only used on machines with rotation stop facility.
- For light chiselling and gouging application on concrete, masonry and natural stone.

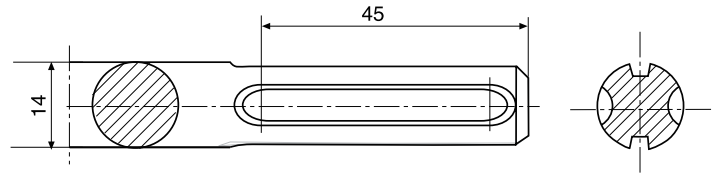

**POINTED CHISEL**



**SCALING CHISEL**



**FLAT CHISEL**



**ANGLED SCRAPING CHISEL**



**WINGED GOUGING CHISEL**



**HOLLOW GOUGING CHISEL**



**SEAM TOOL**



**SLOTING CHISEL**

ITEM NO.	POINT TYPE	WIDTH (MM)	OVERALL LENGTH (MM)
30210301H	bull point	/	250mm
30210302H	flat chisel	20mm	250mm
30210303H	scaling chisel	40mm	250mm
30210304H	gauge	22mm	250mm
30210305H	angled scraping chisel	35mm	200mm
30210306H	angled scraping chisel	40mm	200mm
30210307H	angled scraping chisel	50mm	200mm
30210308H	slotting chisel	24mm	250mm
30210309H	seam tool	27mm	250mm
30210310H	slotting chisel	16mm	190mm
30210311H	Mortar chisel	27mm	250mm
30210312H	hollow gouge	22mm	250mm

ITEM NO.	POINT TYPE	WIDTH (INCH)	OVERALL LENGTH (INCH)
30219301H	bull point	/	10"
30219302H	flat chisel	3/4"	10"
30219303H	scaling chisel	1-9/16"	10"
30219304H	gauge	7/8"	10"
30219305H	angled scraping chisel	1-3/8"	8"
30219306H	angled scraping chisel	1-9/16"	8"
30219307H	angled scraping chisel	2"	8"
30219308H	slotting chisel	15/16"	10"
30219309H	seam tool	1-1/16"	10"
30219310H	slotting chisel	5/8"	7-1/2"
30219311H	mortar chisel	1-1/16"	10"
30219312H	hollow gouge	7/8"	10"

## 3021 / SDS-PLUS SHANK HAMMER STEEL CHISELS

**SDS-PLUS SHANK WITH HEX SHAFT**

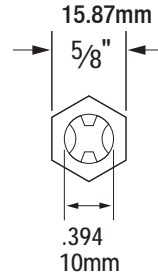

**BULL POINT**



**SCALING CHISEL**



**HOLLOW GOUGE**



**FLAT CHISEL**

ITEM NO.	POINT TYPE	WIDTH (MM)	OVERALL LENGTH (MM)
30210318H	bull point	/	250mm
30210319H	flat chisel	20mm	250mm
30210320H	flat chisel	25mm	250mm
30210321H	flat chisel	35mm	250mm
30210322H	scaling chisel	40mm	250mm
30210323H	scaling chisel	50mm	250mm
30210324H	scaling chisel	75mm	250mm
30210325H	angled scraping	40mm	250mm
30210326H	hollow gouge	22mm	250mm

ITEM NO.	POINT TYPE	WIDTH (INCH)	OVERALL LENGTH (INCH)
30219318H	bull point	/	10"
30219319H	flat chisel	3/4"	10"
30219320H	flat chisel	1"	10"
30219321H	flat chisel	1-3/8"	10"
30219322H	scaling chisel	1-1/2"	10"
30219323H	scaling chisel	2"	10"
30219324H	scaling chisel	3"	10"
30219325H	angled scraping	1-1/2"	10"
30219326H	hollow gouge	7/8"	10"

## 3040 / SDS-MAX SHANK HAMMER STEEL CHISELS

- Only used on hammers with rotation stop facility.
- Fit all heavy duty rotary and demolition hammers with the SDS-Max tool holder system 5 - 12 kg.
- For renovation, restoration, breakthroughs, mortising and demolition work.

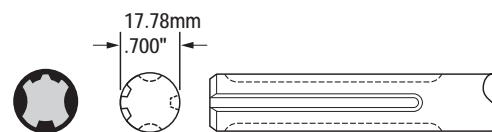

**BULL POINT**



**HOLLOW GAUGE**



**FLAT CHISEL**



**ANGLED  
SCRAPING CHISEL**



**SCALING CHISEL**

ITEM NO.	POINT TYPE	DIMENSION (MM)
30400302H	bull point	280mm
30400303H	bull point	300mm
30400304H	bull point	360mm
30400305H	bull point	400mm
30400306H	bull point	460mm
30400307H	bull point	500mm
30400308H	bull point	600mm
30400309H	flat chisel	25mm x 280mm
30400310H	flat chisel	25mm x 300mm
30400311H	flat chisel	25mm x 300mm
30400301H	flat chisel	25mm x 400mm
30400312H	flat chisel	25mm x 460mm
30400313H	flat chisel	25mm x 500mm
30400314H	flat chisel	25mm x 600mm
30400315H	scaling chisel	50mm x 360mm
30400316H	scaling chisel	50mm x 400mm
30400317H	scaling chisel	50mm x 600mm
30400318H	scaling chisel	80mm x 300mm
30400319H	scaling chisel	115mm x 350mm
30400320H	hollow gauge	25mm x 300mm
30400321H	hollow gauge	33mm x 300mm
30400322H	winged gauge	25mm x 300mm
30400323H	winged gauge	33mm x 380mm
30400324H	angled scraping chisel	50mm x 300mm
30400325H	angled scraping chisel	75mm x 300mm
30400326H	clay spade	110mm x 500mm
30400327H	pointed spade	135mm x 550mm
30400328H	slotting chisel	32mm x 300mm
30400329H	mortar chisel	27mm x 300mm
30400330H	asphalt cutter	125mm x 500mm
30400331H	bushing tool	45mm x 250mm
30400332H	TCT mortar chisel	32mm x 300mm

ITEM NO.	POINT TYPE	DIMENSION (INCH)
30409302H	bull point	11"
30409303H	bull point	12"
30409304H	bull point	14"
30409305H	bull point	16"
30409306H	bull point	18"
30409307H	bull point	20"
30409308H	bull point	24"
30409309H	flat chisel	1" x 11"
30409310H	flat chisel	1" x 12"
30409311H	flat chisel	1" x 14"
30409301H	flat chisel	1" x 16"
30409312H	flat chisel	1" x 18"
30409313H	flat chisel	1" x 20"
30409314H	flat chisel	1" x 24"
30409315H	scaling chisel	2" x 14"
30409316H	scaling chisel	2" x 16"
30409317H	scaling chisel	2" x 24"
30409318H	scaling chisel	3-1/8" x 12"
30409319H	scaling chisel	4-1/2" x 14"
30409320H	hollow gauge	1" x 12"
30409321H	hollow gauge	1-1/4" x 12"
30409322H	winged gauge	1" x 12"
30409323H	winged gauge	1-1/4" x 14"
30409324H	angled scraping chisel	2" x 12"
30409325H	angled scraping chisel	3" x 12"
30409326H	clay spade	4-3/8" x 20"
30409327H	pointed spade	5-1/4" x 22"
30409328H	slotting chisel	1-1/4" x 12"
30409329H	mortar chisel	1-1/8" x 12"
30409330H	asphalt cutter	5" x 20"
30409331H	bushing tool	1-3/4" x 10"
30409332H	TCT mortar chisel	1-1/4" x 12"

## 3044 / CHISELS WITH 3/4" (19mm) HEX DEMO SHANK

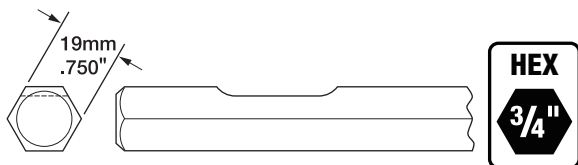

### SUITABLE FOR:

- Heavy rotary and demolition hammers 5 - 12 kg.

### APPLICATION:

- For renovation, restoration, breakthroughs, mortising and demolition work.

	POINT TYPE	BLADE SIZE (MM)	OVERALL LENGTH (MM)
30440301H	bull point	/	300mm
30440302H	bull point	/	380mm
30440303H	bull point	/	400mm
30440304H	bull point	/	450mm
30440305H	bull point	/	500mm
30440306H	bull point	/	600mm
30440307H	flat chisel	25mm	300mm
30440308H	flat chisel	25mm	380mm
30440309H	flat chisel	25mm	400mm
30440310H	flat chisel	25mm	450mm
30440311H	flat chisel	25mm	500mm
30440312H	flat chisel	25mm	600mm
30440313H	scaling chisel	40mm	300mm
30440314H	scaling chisel	40mm	350mm
30440315H	scaling chisel	40mm	400mm
30440316H	hollow gouge	25mm	300mm
30440317H	hollow gouge	33mm	300mm

ITEM NO.	POINT TYPE	BLADE SIZE (INCH)	OVERALL LENGTH (INCH)
30449301H	bull point	/	12"
30449302H	bull point	/	15"
30449303H	bull point	/	16"
30449304H	bull point	/	18"
30449305H	bull point	/	20"
30449306H	bull point	/	24"
30449307H	flat chisel	1"	12"
30449308H	flat chisel	1"	15"
30449309H	flat chisel	1"	16"
30449310H	flat chisel	1"	18"
30449311H	flat chisel	1"	20"
30449312H	flat chisel	1"	24"
30449313H	scaling chisel	1-1/2"	12"
30449314H	scaling chisel	1-1/2"	14"
30449315H	scaling chisel	1-1/2"	16"
30449316H	hollow gouge	1"	12"
30449317H	hollow gouge	1-1/4"	12"



#### POINTED CHISEL

Starts holes in concrete slabs, general chipping & breaking.



#### SCALING CHISEL

For removing large quantities of materials.



#### FLAT CHISEL

For general chiseling and breaking work in brickwork, concrete and loose stone, for example when laying cables.



#### Hollow Gouging Chisel

For cutting narrow channels into concrete.



## 3048 CHISELS WITH ROUND SPLINE DRIVE SHANK

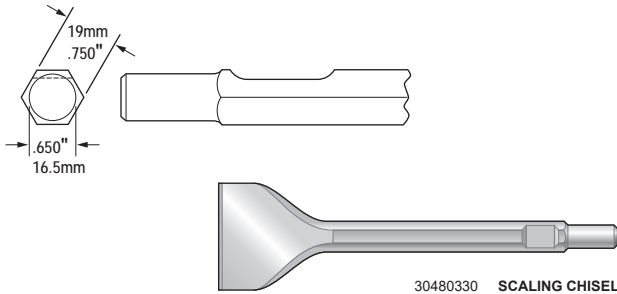

### SUITABLE FOR:

- Heavy rotary and demolition hammers 5 - 12 kg.

### APPLICATION:

- For renovation, restoration, breakthroughs, mortising and demolition work.

ITEM NO.	POINT TYPE	BLADE SIZE (MM)	OVERALL LENGTH (MM)
30480320H	bull point	/	300mm
30480321H	bull point	/	380mm
30480322H	bull point	/	400mm
30480323H	bull point	/	450mm
30480324H	bull point	/	600mm
30480325H	flat chisel	20mm	300mm
30480326H	flat chisel	25mm	380mm
30480327H	flat chisel	25mm	400mm
30480328H	flat chisel	25mm	450mm
30480329H	flat chisel	25mm	600mm
30480330H	scaling chisel	50mm	300mm
30480331H	scaling chisel	50mm	350mm
30480332H	scaling chisel	50mm	400mm
30480333H	scaling chisel	75mm	300mm
30480334H	scaling chisel	75mm	350mm
30480335H	hollow gouge	25mm	250mm
30480336H	hollow gouge	25mm	300mm
30480337H	hollow gouge	33mm	300mm
30480338H	angled scraping	75mm	300mm
30480339H	clay spade	110mm	500mm
30480340H	asphalt cutter	125mm	500mm
30480341H	bushing tool	45mm	240mm

ITEM NO.	POINT TYPE	BLADE SIZE (INCH)	OVERALL LENGTH (INCH)
30489320H	bull point	/	12"
30489321H	bull point	/	15"
30489322H	bull point	/	16"
30489323H	bull point	/	18"
30489324H	bull point	/	24"
30489325H	flat chisel	3/4"	12"
30489326H	flat chisel	1"	15"
30489327H	flat chisel	1"	16"
30489328H	flat chisel	1"	18"
30489329H	flat chisel	1"	24"
30489330H	scaling chisel	2"	12"
30489331H	scaling chisel	2"	14"
30489332H	scaling chisel	2"	16"
30489333H	scaling chisel	3"	12"
30489334H	scaling chisel	3"	14"
30489335H	hollow gouge	1"	10"
30489336H	hollow gouge	1"	12"
30489337H	hollow gouge	1-1/4"	12"
30489338H	angled scraping	3"	12"
30489339H	clay spade	4-3/8"	20"
30489340H	asphalt cutter	5"	20"
30489341H	bushing tool	1-3/4"	9-1/2"



#### BULL POINT

Starts holes in concrete slabs, general chipping & breaking.



#### FLAT CHISEL

For general chiseling and breaking work in brickwork, concrete and loose stone, for example when laying cables.



#### BUSHING TOOL

Ideal for leveling concrete surfaces and removing excess concrete during finishing work. Additional, bushing tools can be used to roughen a smooth concrete to prepare the surface for additional concrete or a coating.



#### SCALING CHISEL

For removing large quantities of materials.



#### ANGLED SCRAPING CHISEL/ Tile Chisel

For easy removal of tiles ( with ergonomically angled working end )



#### Hollow Gouging Chisel

For cutting narrow channels into concrete.

## 3049 / CHISELS WITH 1-1/8" (28MM) HEX SHANK

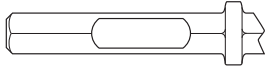
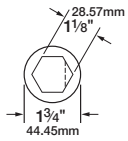

### SUITABLE FOR:

- Heavy demolition hammers >12 kg.

### APPLICATION:

- For breakthroughs, mortising and demolition work.

ITEM NO.	POINT TYPE	BLADE SIZE (MM)	OVERALL LENGTH (MM)
30490301H	bull point	/	450mm
30490302H	bull point	/	500mm
30490303H	flat chisel	25mm	450mm
30490304H	flat chisel	25mm	500mm
30490305H	scaling chisel	75mm	400mm
30490306H	scaling chisel	75mm	500mm
30490307H	clay spade	110mm	500mm
30490308H	asphalt cutter	125mm	500mm

ITEM NO.	POINT TYPE	BLADE SIZE (INCH)	OVERALL LENGTH (INCH)
30499301H	bull point	/	18"
30499302H	bull point	/	20"
30499303H	flat chisel	1"	18"
30499304H	flat chisel	1"	20"
30499305H	scaling chisel	3"	16"
30499306H	scaling chisel	3"	20"
30499307H	clay spade	4-3/8"	20"
30499308H	asphalt cutter	5"	20"



### POINTED CHISEL

Starts holes in concrete slabs, general chipping & breaking.



### FLAT CHISEL

For general chiseling and breaking work in brickwork, concrete and loose stone, for example when laying cables.



### ASPHALT CUTTER

For chiselling, channelling, and demolition tasks in concrete, stone (medium hardness), floor and wall tiles, general masonry and mortar.

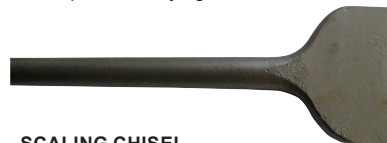

### SCALING CHISEL

For removing large quantities of materials.



### CLAY SPADE

Digging out clay or hard packed gravel.

## 3074 / CHISELS WITH 17MM HEX SHANK

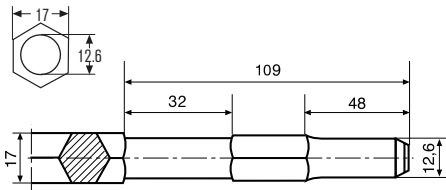

30740301



30740304

### SUITABLE FOR:

- Heavy rotary and demolition hammers 5 - 12 kg.

### APPLICATION:

- For renovation, restoration, breakthroughs, mortising and demolition work.

ITEM NO.	POINT TYPE	BLADE SIZE (MM)	OVERALL LENGTH (MM)
30740350H	bull point	/	280mm
30740351H	bull point	/	360mm
30740352H	bull point	/	450mm
30740353H	flat chisel	25mm	280mm
30740354H	flat chisel	25mm	360mm
30740355H	flat chisel	25mm	450mm
30740356H	scaling chisel	50mm	280mm
30740357H	scaling chisel	50mm	450mm
30740358H	scaling chisel	75mm	280mm
30740359H	hollow gouge	22mm	300mm

ITEM NO.	POINT TYPE	BLADE SIZE (INCH)	OVERALL LENGTH (INCH)
30749350H	bull point	/	11"
30749351H	bull point	/	14"
30749352H	bull point	/	18"
30749353H	flat chisel	1"	11"
30749354H	flat chisel	1"	14"
30749355H	flat chisel	1"	18"
30749356H	scaling chisel	2"	11"
30749357H	scaling chisel	2"	18"
30749358H	scaling chisel	3"	11"
30749359H	hollow gouge	7/8"	12"



### POINTED CHISEL

Starts holes in concrete slabs, general chipping & breaking.



### Hollow Gouging Chisel

For cutting narrow channels into concrete.



### FLAT CHISEL

For general chiseling and breaking work in brickwork, concrete and loose stone, for example when laying cables.

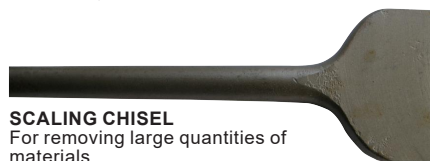

### SCALING CHISEL

For removing large quantities of materials.

## 3075 / KANGO 21MM HEX SHANK BREAKER STEELS

### Kango 950

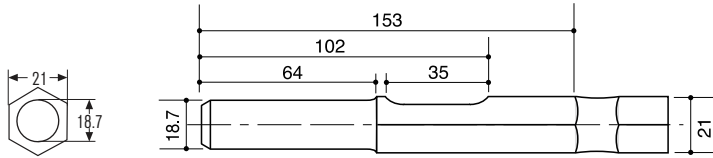

#### SUITABLE FOR:

- Kango 900K, 950 K/KV and many other breakers.

#### APPLICATION:

- For general breaking work.
- For breaking, chiselling and render removal of Masonry, stone, brick & concrete.



**BULL POINT**



**FLAT CHISEL**

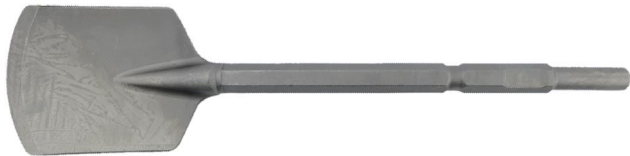

**CLAY SPADE**



**SCALING CHISEL**



**HOLLOW GOUGE**



ITEM NO.	POINT TYPE	WIDTH	OVERALL LENGTH
30750301H	bull point	/	380mm
30750302H	bull point	/	450mm
30750303H	flat chisel	25mm	380mm
30750304H	flat chisel	25mm	450mm
30750305H	scaling chisel	50mm	300mm
30750306H	scaling chisel	75mm	300mm
30750307H	clay spade	100mm	165mm
30750308H	hollow gouge	30mm	250mm

ITEM NO.	POINT TYPE	WIDTH	OVERALL LENGTH
30759301H	bull point	/	15"
30759302H	bull point	/	18"
30759303H	flat chisel	1"	15"
30759304H	flat chisel	1"	18"
30759305H	scaling chisel	2"	12"
30759306H	scaling chisel	3"	12"
30759307H	clay spade	4"	6-1/2"
30759308H	hollow gouge	1-3/16"	10"

## 3021/ 3040/ 3074

## HAMMER STEEL FLOOR SCRAPERS

### SUITABLE FOR:

- Floor scrapers have a flat blade that removes glue, laminate, and other materials from floor surfaces.
- The blade can be replaced if it becomes worn or damaged.

### APPLICATION:

- For use on jobs involving removal of ceramic tile, thinset, carpet, epoxy, vinyl and other dried stubborn adhesives, also the glued down wood floors and hardwood floor.
- Suitable for rotary and demolition hammer drills.



### SDS-PLUS SHANK

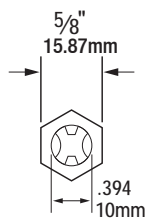

30210340H



30210339H

### SDS-MAX SHANK

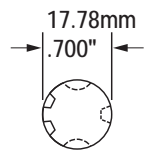

30210333H



30400347H

### 17MM HEX SHANK

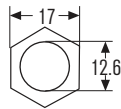

30740314H



30740311H

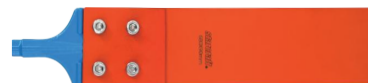

30740315H

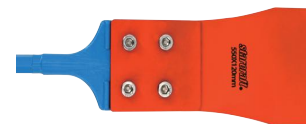

30740316H

ITEM NO.	POINT TYPE	WIDTH	OVERALL LENGTH
30210332H	SDS-Plus	125mm	250mm
30210333H	SDS-Plus	150mm	250mm
30210334H	SDS-Plus	75mm	300mm
30210335H	SDS-Plus	100mm	300mm
30210336H	SDS-Plus	125mm	300mm
30210337H	SDS-Plus	150mm	300mm
30210338H	SDS-Plus	100mm	265mm
30210339H	SDS-Plus	125mm	275mm
30210340H	SDS-Plus	150mm	275mm
30210341H	SDS-Plus	75mm	165mm
30400333H	SDS-Max	150mm	300mm
30400347H	SDS-Max	200mm	610mm
30740310H	17mm hex	100mm	280mm
30740311H	17mm heX	125mm	280mm
30740312H	17mm hex	75mm	300mm
30740313H	17mm hex	100mm	300mm
30740314H	17mm hex	125mm	300mm
30740315H	17mm hex	120mm	550mm
30740316H	17mm hex	90mm	680mm

ITEM NO.	POINT TYPE	WIDTH	OVERALL LENGTH
30219332H	SDS-Plus	5"	10"
30219333H	SDS-Plus	6"	10"
30219334H	SDS-Plus	3"	12"
30219335H	SDS-Plus	4"	12"
30219336H	SDS-Plus	5"	12"
30219337H	SDS-Plus	6"	12"
30219338H	SDS-Plus	4"	10-7/16"
30219339H	SDS-Plus	5"	10-13/16"
30219340H	SDS-Plus	6"	10-13/16"
30219341H	SDS-Plus	3"	6-1/2"
30409333H	SDS-Max	6"	12"
30409347H	SDS-Max	8"	24"
30749310H	17mm hex	4"	11"
30749311H	17mm heX	5"	11"
30749312H	17mm hex	3"	12"
30749313H	17mm hex	4"	12"
30749314H	17mm hex	5"	12"
30749315H	17mm hex	4-3/4"	22"
30749316H	17mm hex	3-9/16"	27"

**3094 / EARTH AUGER BITS, SINGLE SPIRAL BLADE**



**APPLICATIONS:**

- For drilling holes for planting thick trunk trees and for hammering in various type of pile.
- Suitable for drilling earth sandy soil and soil containing grassroots.
- Use with power earth auger.

**FEATURES:**

- Single spiral blade Carbide tipped pilot drill bit 2 flat cutters for soil with grassroots.

ITEM NO.	DIA.	OVERALL LENGTH
30940201I	Φ40mm	800mm
30940202I	Φ60mm	800mm
30940203I	Φ80mm	800mm
30940204I	Φ100mm	800mm
30940205I	Φ120mm	800mm
30940206I	Φ150mm	800mm
30940207I	Φ200mm	800mm
30940208I	Φ250mm	800mm
30940209I	Φ300mm	800mm
30940210I	Φ350mm	800mm



**EARTH AUGER BITS**

## 3095 / EARTH AUGER BITS, SINGLE SPIRAL BLADE



### APPLICATIONS:

- For drilling holes for planting thick trunk trees and for hammering in various type of pile.
- Suitable for drilling sandy soil and soil containing grassroots.
- Use with power earth auger.

### FEATURES:

- Single spiral blade Threaded point 2 flat cutters for soil with grassroots.

ITEM NO.	DIA.	OVERALL LENGTH
30950201I	Φ60mm	800mm
30950202I	Φ80mm	800mm
30950203I	Φ100mm	800mm
30950204I	Φ120mm	800mm
30950205I	Φ150mm	800mm
30950206I	Φ200mm	800mm
30950207I	Φ250mm	800mm
30950208I	Φ300mm	800mm
30950209I	Φ350mm	800mm
30950210I	Φ400mm	800mm
30950211I	Φ500mm	800mm
30950212I	Φ600mm	800mm

## 3096 / DOUBLE BLADES WITH ALLOY BLADES SERIES



### APPLICATIONS:

- For drilling holes for planting thick trunk trees and for hammering in various type of pile.
- Suitable for drilling sandy soil and soil containing grassroots and pebbles.
- Use with power earth auger.

### FEATURES:

- Double spiral blades allow for faster soil removal compared to single blade augers.
- Threaded tip.
- Replaceable dual cutters for each diameter auger bit
- Flat cutters for soil with grassroots and sharp cutter suitable for soil with pebbles.

ITEM NO.	DIA.	OVERALL LENGTH
30960201I	Φ60mm	800mm
30960202I	Φ80mm	800mm
30960203I	Φ100mm	800mm
30960204I	Φ120mm	800mm
30960205I	Φ150mm	800mm
30960206I	Φ200mm	800mm
30960207I	Φ250mm	800mm
30960208I	Φ300mm	800mm

**3098 / ICE AUGER BITS**



**ICE AUGER BITS**



**APPLICATIONS:**

- For ice burrowing for ice fishing or other cold-weather activities.
- Perfectly suited to meet the needs of seasoned ice fishers.
- Use with power auger.

**FEATURES:**

- Single spiral blade
- Replaceable centering spear point cutter stabilizes your drilling, keeping the drill steady and aligned for clean, accurate holes every time, even on uneven ice surfaces.
- Replaceable dual stainless steel cutters ensure a smooth, clean cut every time.
- Serrated cutters designed ensures rapid ice penetration.

ITEM NO.	DIA.	OVERALL LENGTH
30980201I	Φ60mm	800mm
30980202I	Φ80mm	800mm
30980203I	Φ100mm	800mm
30980204I	Φ120mm	800mm
30980205I	Φ150mm	800mm
30980206I	Φ200mm	800mm
30980207I	Φ250mm	800mm
30980208I	Φ300mm	800mm

**30970201E / EXTENSION ROD WITH SPRING**



- 200mm auger shaft extension.
- 20mm male /female connecting end. shaft with spring for impact release.
- Suitable for most power earth augers

**3097 / EXTENSION ROD**



- 300~1000mm auger shaft extension.
- 200mm male /female connecting end.
- Suitable for most power earth augers.

ITEM NO.	OVERALL LENGTH
30970202I	300mm
30970203I	500mm
30970204I	700mm
30970205I	1000mm



***starcraft***®

QUALITY · VALUE · INNOVATION

**Enjoy Work!  
Enjoy Life!**

**[www.starcrafttools.com](http://www.starcrafttools.com)**



Add: No. 880 Xingwen Road, Jiading, Shanghai, China  
Tel: 0086-21-33517000, 33517100  
Email: [sales@starcraftgroup.com](mailto:sales@starcraftgroup.com)  
Copyright © 2026